

How to Select Pallet Rack Frames & Beams

Letters A through E refer to the diagram at right.

A. Height: Measure the height of the pallet and pallet load. Add an extra 4" to 6". Total is the required vertical clearance between beams or between floor and bottom of the first beam. (Beam spacing is in 3" increments.)

B. Depth: Measure the depth of the pallet. Pallet should overhang the beams by 3" to 4" front and back. (Example: for a 48" deep pallet use a 42" deep frame.)

C. Width: Measure the width of the load and pallet, and use the greater of the two. Add 3" to 4" between loads, and between loads and upright frames to determine correct beam length. Select beams with a capacity equal to or greater than the total load of each level.

D. Frame Capacity: Add the total of all loads for each bay (exclude the pallets on the floor), and review allowable upright frame loads based on the beam spacing (see chart below). Pick the appropriate capacity Upright in the size you need.

E. A common frame should be used between each of the sections.

Rack Upright Frame Configurations

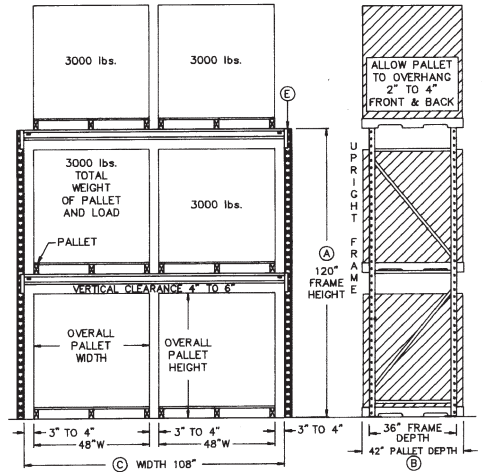
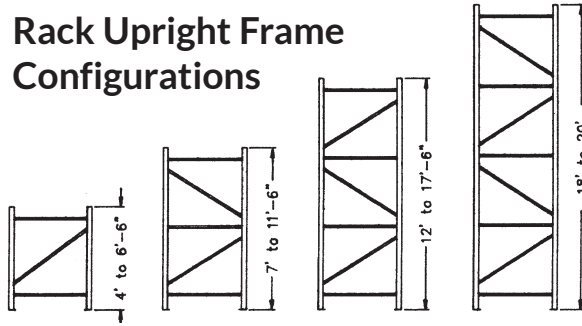

General Information

Anchoring: All pallet rack upright frames shall be anchored to the floor. Anchors are sold separately; see Pallet Rack Accessories.

Beam Capacities are shown per pair, in pounds.

The capacity is calculated in compliance with RMI Specifications and AISI Standard. Calculations assume uniform load distribution. Beams of 138" and 144" span require a minimum of two (2) Heavy Duty Cross Bars.

'Traditional' Colors: Frames-028 Gray; Beams-710 Yellow; Accessories-028 Gray except for Frame Protectors (710 Yellow). Any of our standard colors can be ordered.

When ordering accessories, be sure to match the proper accessories with the beam step (either 7/8" or 1-5/8").

Frame Capacities Are calculated in compliance with Rack Manufacturer's Institute (RMI) Specifications and AISI Standard. Load data shown is for preliminary consideration only. Each installation must be individually evaluated for actual conditions and the use of each element in relation to the entire system with all aspects of the structural function. Frame capacities shown here are representative for most areas. In places where seismic activity is known to occur, we advise you to contact your Penco representative for assistance. You may want to order Pallet Rack PLUS instead (see box at right).

Pallet Rack PLUS

For Severe Conditions or High Seismic Activity

Pallet Rack Plus load capacities are the same as standard pallet rack shown in this price book, however the frames and beams are more resistant to horizontal and vertical forces that could damage standard rack and its load. To learn the seismic rating where your pallet rack will be in use, contact your Penco representative.

Beams: The *Plus* beams have 4 connectors instead of 3 for a stronger connection between the beam and the upright post. The beam is welded 3" down from the top of the connector so loading is evenly distributed across all four connector prongs. The beam locking key is the same as used on standard beams.

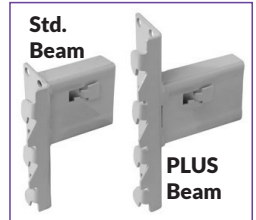

To Order PLUS BEAMS: ADD A "P" SUFFIX TO THE PART NUMBER, ADD \$34.95 TO THE PRICE/PAIR AND ADD 3 LBS TO THE WEIGHT per PAIR.

Upright Frames: Each *Plus* upright frame has two 5" x 7" x 3/8" thick footplates with four 9/16" diameter anchoring holes. The extra holes provide the installer with more choices for floor anchoring. **To Order PLUS FRAMES:** REPLACE THE 'C' PART NUMBER SUFFIX WITH A "PC" SUFFIX, ADD \$69.85 TO THE PRICE AND 6 LBS TO THE WEIGHT.

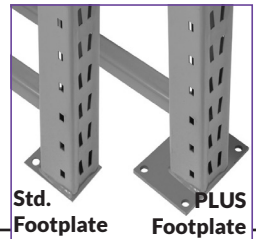

PALLET RACK UPRIGHT FRAME CAPACITY CHART

Allowable Upright load in Pounds

FRAME TYPE	Beam Spacing (Inches)											
	24	30	36	42	48	54	60	66	72	78	84	90
F	22,555	21,213	19,853	18,528	16,929	15,381	13,543	11,773	9,824	8,439	7,216	6,336
G	26,512	25,236	23,839	22,311	20,663	18,904	17,025	15,015	12,864	10,774	9,306	8,110
P	32,751	31,227	29,555	27,932	25,965	24,342	21,871	19,203	17,212	14,630	12,540	11,026
R	39,108	37,264	35,464	33,266	30,891	28,339	25,934	23,043	19,959	17,245	14,796	12,834
T	45,629	43,478	41,102	38,503	35,715	32,703	29,897	26,489	22,875	19,432	16,713	14,527

Other Options Penco also manufactures Double Posted Frames and Cantilever Leg Frames to RMI, ANSI and other custom requirements. Contact your Sales Representative for pricing.

Pallet Rack Component Parts



W	D	H *	Cat. No.	Price	Per	Wt.	Pkg.
---	---	-----	----------	-------	-----	-----	------

General Duty Cross Bars, 16 Ga.

For 7/8" Step Beam

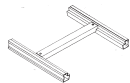

30	5AX530C	22.15	Ea.	3.6
36	5AX536C	24.90	Ea.	4.4
42	5AX542C	28.50	Ea.	5.3
48	5AX548C	32.40	Ea.	6.1
54	5AX554C	36.50	Ea.	6.8
60	5AX560C	39.75	Ea.	7.5

For 1-5/8" Step Beam

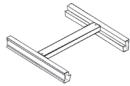

30	5AX630C	20.95	Ea.	3.6
36	5AX636C	24.15	Ea.	4.4
42	5AX642C	27.70	Ea.	5.3
48	5AX648C	31.05	Ea.	6.1
54	5AX654C	34.00	Ea.	6.8
60	5AX660C	38.05	Ea.	7.5

Heavy Duty Flanged Cross Bars, 16 Ga.

For 1-5/8" Step Beams

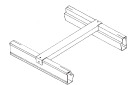

30	5AX730C	26.80	Ea.	4.5
36	5AX736C	29.35	Ea.	5.3
42	5AX742C	33.20	Ea.	6.1
48	5AX748C	36.95	Ea.	6.9
54	5AX754C	40.70	Ea.	7.7
60	5AX760C	44.90	Ea.	8.5

Plywood Supports, 16 Ga.

When used as a deck support (for plywood, particle board, etc.) we recommend that the center support be securely fastened (using Tek screw #8822) to both the front and rear beams. Plywood depth should be Frame depth minus 3-3/4".

For 7/8" Step Beam, 1/2" Deck



30	5AP230C	14.90	Ea.	3.6
36	5AP236C	17.50	Ea.	4.4
42	5AP242C	19.70	Ea.	5.3
48	5AP248C	22.15	Ea.	6.1

For 1-5/8" Step Beam, 3/4" Deck

30	5AP330	22.15	Ea.	3.6
36	5AP336	24.90	Ea.	4.4
42	5AP342	28.50	Ea.	5.3
48	5AP348	32.40	Ea.	6.1
54	5AP354	36.50	Ea.	6.8
60	5AP360	39.75	Ea.	7.5

Heavy Duty Skid Channels

11 Ga., 4" Wide Runners

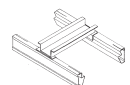

30	5AS230C	45.95	Ea.	9.3
36	5AS236C	51.30	Ea.	11.1
42	5AS242C	57.50	Ea.	12.9
48	5AS248C	63.25	Ea.	14.7

Fork Clearance Bars

11 Ga.

Raises unpalletized loads by 2-3/4".

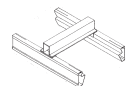

30	5AF330C	42.20	Ea.	9.0
36	5AF336C	46.90	Ea.	10.7
42	5AF342C	52.60	Ea.	12.5
48	5AF348C	58.05	Ea.	14.2
54	5AF354C	63.80	Ea.	16.0
60	5AF360C	69.20	Ea.	17.7

Coil Bed Assembly

7 Ga., Full Depth

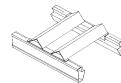

30	5AC030C	98.55	Ea.	21.0
36	5AC036C	111.65	Ea.	25.0
42	5AC042C	126.05	Ea.	29.0
48	5AC048C	138.40	Ea.	33.0

Wire Shelf Decking is available for RivetRite. Please contact your Penco Representative for more information.

PENCO

When Every Second Counts™

First responder lockers designed for the secure and economical storage of your gear. These lockers will keep your belongings and gear safe and ready for that critical first response.

PATRIOT®

RapidResponse™
DUFFEL LOCKER

For more information contact your Penco Sales Representative

*Patriot® and Rapid Response Duffel™ Lockers are not available through QuickShip

The price books are only for reference, if there are any discrepancies between the price book and EQ, EQ will override the price book.
Order by Catalog Number Only



Standard Pallet Rack Upright Frames



Frame Type F

3" wide x 1-3/4" deep Post - 14 Gauge

W	H	PART #	PRICE	WT.	W	H	PART #	PRICE	WT.	W	H	PART #	PRICE	WT.	W	H	PART #	PRICE	WT.
30	48	5FB048C	111.85	25.0	30	102	5FB102C	209.90	47.0	30	156	5FB156C	324.20	72.0	30	210	5FB210C	426.70	94.0
36	48	5FE048C	117.35	26.0	36	102	5FE102C	219.15	49.0	36	156	5FE156C	331.75	74.0	36	210	5FE210C	434.25	95.0
42	48	5FH048C	123.20	27.0	42	102	5FH102C	228.55	52.0	42	156	5FH156C	345.70	79.0	42	210	5FH210C	447.60	99.0
48	48	5FL048C	128.75	29.0	48	102	5FL102C	237.60	55.0	48	156	5FL156C	358.95	81.0	48	210	5FL210C	457.40	101.0
54	48	5FP048C	133.25	30.0	54	102	5FP102C	243.80	56.0	54	156	5FP156C	371.65	86.0	54	210	5FP210C	468.05	104.0
60	48	5FS048C	138.45	32.0	60	102	5FS102C	252.45	59.0	60	156	5FS156C	380.30	87.0	60	210	5FS210C	475.55	106.0
30	54	5FB054C	120.15	26.0	30	108	5FB108C	225.55	51.0	30	162	5FB162C	331.75	74.0	30	216	5FB216C	450.70	98.0
36	54	5FE054C	125.50	27.0	36	108	5FE108C	231.00	52.0	36	162	5FE162C	340.15	76.0	36	216	5FE216C	460.75	100.0
42	54	5FH054C	131.25	29.0	42	108	5FH108C	240.15	55.0	42	162	5FH162C	354.00	71.0	42	216	5FH216C	478.25	104.0
48	54	5FL054C	136.95	31.0	48	108	5FL108C	249.55	57.0	48	162	5FL162C	367.65	82.0	48	216	5FL216C	495.75	109.0
54	54	5FP054C	140.65	32.0	54	108	5FP108C	259.65	60.0	54	162	5FP162C	380.70	87.0	54	216	5FP216C	513.10	113.0
60	54	5FS054C	148.70	34.0	60	108	5FS108C	265.25	61.0	60	162	5FS162C	388.55	89.0	60	216	5FS216C	521.70	117.0
30	60	5FB060C	131.25	29.0	30	114	5FB114C	233.35	53.0	30	168	5FB168C	340.40	76.0	30	222	5FB222C	455.20	100.0
36	60	5FE060C	136.05	30.0	36	114	5FE114C	239.15	54.0	36	168	5FE168C	348.80	78.0	36	222	5FE222C	460.75	102.0
42	60	5FH060C	149.55	32.0	42	114	5FH114C	248.20	57.0	42	168	5FH168C	362.10	82.0	42	222	5FH222C	481.80	106.0
48	60	5FL060C	147.60	33.0	48	114	5FL114C	257.85	59.0	48	168	5FL168C	375.15	84.0	48	222	5FL222C	499.10	111.0
54	60	5FP060C	153.00	35.0	54	114	5FP114C	267.25	62.0	54	168	5FP168C	389.75	89.0	54	222	5FP222C	516.75	116.0
60	60	5FS060C	161.00	35.0	60	114	5FS114C	272.85	63.0	60	168	5FS168C	397.05	91.0	60	222	5FS222C	516.75	116.0
30	66	5FB066C	140.30	31.0	30	120	5FB120C	241.90	54.0	30	174	5FB174C	351.85	78.0	30	228	5FB228C	464.05	101.0
36	66	5FE066C	143.95	32.0	36	120	5FE120C	246.55	56.0	36	174	5FE174C	359.65	80.0	36	228	5FE228C	473.30	104.0
42	66	5FH066C	156.10	34.0	42	120	5FH120C	256.75	59.0	42	174	5FH174C	373.70	84.0	42	228	5FH228C	491.30	108.0
48	66	5FL066C	155.75	35.0	48	120	5FL120C	265.55	60.0	48	174	5FL174C	387.40	86.0	48	228	5FL228C	508.20	112.0
54	66	5FP066C	161.00	36.0	54	120	5FP120C	275.95	63.0	54	174	5FP174C	401.05	90.0	54	228	5FP228C	525.70	118.0
60	66	5FS066C	165.30	37.0	60	120	5FS120C	281.00	65.0	60	174	5FS174C	409.05	92.0	60	228	5FS228C	525.70	118.0
30	72	5FB072C	152.30	33.0	30	126	5FB126C	260.50	56.0	30	180	5FB180C	361.25	80.0	30	234	5FB234C	473.30	103.0
36	72	5FE072C	156.75	34.0	36	126	5FE126C	266.55	58.0	36	180	5FE180C	369.30	82.0	36	234	5FE234C	482.75	106.0
42	72	5FH072C	161.85	35.0	42	126	5FH126C	277.55	61.0	42	180	5FH180C	382.80	86.0	42	234	5FH234C	500.60	110.0
48	72	5FL072C	165.00	36.0	48	126	5FL126C	285.95	62.0	48	180	5FL180C	395.95	88.0	48	234	5FL234C	517.45	115.0
54	72	5FP072C	171.25	38.0	54	126	5FP126C	296.30	65.0	54	180	5FP180C	410.20	92.0	54	234	5FP234C	535.50	120.0
60	72	5FS072C	176.95	39.0	60	126	5FS126C	302.85	68.0	60	180	5FS180C	417.65	95.0	60	234	5FS234C	535.50	120.0
30	78	5FB078C	164.50	34.0	30	132	5FB132C	277.55	58.0	30	186	5FB186C	370.35	81.0	30	240	5FB240C	482.45	105.0
36	78	5FE078C	168.90	35.0	36	132	5FE132C	283.20	59.0	36	186	5FE186C	378.40	83.0	36	240	5FE240C	491.85	107.0
42	78	5FH078C	174.70	37.0	42	132	5FH132C	291.90	63.0	42	186	5FH186C	391.15	88.0	42	240	5FH240C	509.60	112.0
48	78	5FL078C	178.70	38.0	48	132	5FL132C	300.50	64.0	48	186	5FL186C	405.20	90.0	48	240	5FL240C	527.05	117.0
54	78	5FP078C	185.25	40.0	54	132	5FP132C	308.45	68.0	54	186	5FP186C	418.40	95.0	54	240	5FP240C	544.40	121.0
60	78	5FS078C	190.95	42.0	60	132	5FS132C	314.55	69.0	60	186	5FS186C	426.70	97.0	60	240	5FS240C	544.40	121.0
30	84	5FB084C	190.35	42.0	30	138	5FB138C	285.75	60.0	30	192	5FB192C	386.05	85.0	30	246	5FB246C	491.85	107.0
36	84	5FE084C	196.90	43.0	36	138	5FE138C	291.45	61.0	36	192	5FE192C	393.85	87.0	36	246	5FE246C	500.60	110.0
42	84	5FH084C	205.80	46.0	42	138	5FH138C	301.30	64.0	42	192	5FH192C	406.25	91.0	42	246	5FH246C	517.45	115.0
48	84	5FL084C	211.95	50.0	48	138	5FL138C	308.75	66.0	48	192	5FL192C	420.75	94.0	48	246	5FL246C	535.50	120.0
54	84	5FP084C	221.25	51.0	54	138	5FP138C	316.80	70.0	54	192	5FP192C	430.05	97.0	54	246	5FP246C	544.40	121.0
60	84	5FS084C	231.00	54.0	60	138	5FS138C	322.90	71.0	60	192	5FS192C	442.75	100.0	60	246	5FS246C	544.40	121.0
30	90	5FB090C	194.90	44.0	30	144	5FB144C	301.30	65.0	30	198	5FB198C	395.05	87.0	30	252	5FB252C	500.60	110.0
36	90	5FE090C	204.35	45.0	36	144	5FE144C	314.75	68.0	36	198	5FE198C	402.30	89.0	36	252	5FE252C	509.60	112.0
42	90	5FH090C	214.60	48.0	42	144	5FH144C	325.90	73.0	42	198	5FH198C	416.15	92.0	42	252	5FH252C	527.05	117.0
48	90	5FL090C	223.75	51.0	48	144	5FL144C	341.85	77.0	48	198	5FL198C	429.70	97.0	48	252	5FL252C	544.40	121.0
54	90	5FP090C	230.10	53.0	54	144	5FP144C	350.65	79.0	54	198	5FP198C	439.85	99.0	54	252	5FP252C	544.40	121.0
60	90	5FS090C	239.15	56.0	60	144	5FS144C	364.05	83.0	60	198	5FS198C	448.55	102.0	60	252	5FS252C	544.40	121.0
30	96	5FB096C	203.10	46.0	30	150	5FB150C	304.50	68.0	30	204	5FB204C	410.70	91.0	30	258	5FB258C	500.60	110.0
36	96	5FE096C	213.15	47.0	36	150	5FE150C	317.70	70.0	36	204	5FE204C	419.30	94.0	36	258	5FE258C	509.60	112.0
42	96	5FH096C	221.95	50.0	42	150	5FH150C	331.35	75.0	42	204	5FH204C	432.65	97.0	42	258	5FH258C	527.05	117.0
48	96	5FL096C	230.45	53.0	48	150	5FL150C	345.30	79.0	48	204	5FL204C	442.75	99.0	48	258	5FL258C	544.40	121.0
54	96	5FP096C	237.00	55.0	54	150	5FP150C	352.55	81.0	54	204	5FP204C	450.10	102.0	54	258	5FP258C	544.40	121.0
60	96	5FS096C	246.55	58.0	60	150	5FS150C	366.40	85.0	60	204	5FS204C	458.45	104.0	60	258	5FS258C	544.40	121.0

See Pallet Rack Upright Frame Capacity Chart for frame capacity at various beam spacing.



Standard Pallet Rack Upright Frames Frame Type G



3" wide x 2-1/4" deep Post - 14 Gauge

W	H	PART #	PRICE	WT.	W	H	PART #	PRICE	WT.	W	H	PART #	PRICE	WT.	W	H	PART #	PRICE	WT.
30	48	5GB048C	119.45	27.0	30	102	5GB102C	224.35	52.0	30	156	5GB156C	347.45	79.0	30	210	5GB210C	461.30	102.0
36	48	5GE048C	124.85	28.0	36	102	5GE102C	233.10	53.0	36	156	5GE156C	355.30	81.0	36	210	5GE210C	468.05	104.0
42	48	5GH048C	130.50	29.0	42	102	5GH102C	242.45	56.0	42	156	5GH156C	368.50	85.0	42	210	5GH210C	479.05	108.0
48	48	5GL048C	136.15	31.0	48	102	5GL102C	251.85	59.0	48	156	5GL156C	381.85	87.0	48	210	5GL210C	491.30	110.0
54	48	5GP048C	139.95	32.0	54	102	5GP102C	257.85	61.0	54	156	5GP156C	395.95	92.0	54	210	5GP210C	502.20	113.0
60	48	5GS048C	145.35	34.0	60	102	5GS102C	267.25	64.0	60	156	5GS156C	403.15	95.0	60	210	5GS210C	508.50	115.0
30	54	5GB054C	128.50	29.0	30	108	5GB108C	240.60	55.0	30	162	5GB162C	356.90	81.0	30	216	5GB216C	484.75	107.0
36	54	5GE054C	134.40	30.0	36	108	5GE108C	246.55	57.0	36	162	5GE162C	364.75	83.0	36	216	5GE216C	494.85	109.0
42	54	5GH054C	139.95	31.0	42	108	5GH108C	256.25	60.0	42	162	5GH162C	378.40	85.0	42	216	5GH216C	512.55	114.0
48	54	5GL054C	145.35	33.0	48	108	5GL108C	265.25	61.0	48	162	5GL162C	391.15	89.0	48	216	5GL216C	530.50	119.0
54	54	5GP054C	148.90	34.0	54	108	5GP108C	274.90	64.0	54	162	5GP162C	405.20	95.0	54	216	5GP216C	547.50	123.0
60	54	5GS054C	155.45	36.0	60	108	5GS108C	279.60	66.0	60	162	5GS162C	412.60	97.0	60	216	5GS216C	557.35	126.0
30	60	5GB060C	140.65	32.0	30	114	5GB114C	249.20	57.0	30	168	5GB168C	366.30	83.0	30	222	5GB222C	492.40	109.0
36	60	5GE060C	145.35	33.0	36	114	5GE114C	255.65	59.0	36	168	5GE168C	373.70	85.0	36	222	5GE222C	497.20	111.0
42	60	5GH060C	149.55	34.0	42	114	5GH114C	265.25	62.0	42	168	5GH168C	387.00	89.0	42	222	5GH222C	514.30	116.0
48	60	5GL060C	156.75	35.0	48	114	5GL114C	279.60	63.0	48	168	5GL168C	401.05	91.0	48	222	5GL222C	531.10	121.0
54	60	5GP060C	161.85	37.0	54	114	5GP114C	282.00	66.0	54	168	5GP168C	414.10	97.0	54	222	5GP222C	548.50	125.0
60	60	5GS060C	169.70	38.0	60	114	5GS114C	288.40	69.0	60	168	5GS168C	421.95	99.0	60	222	5GS222C	548.50	125.0
30	66	5GB066C	151.65	34.0	30	120	5GB120C	258.25	59.0	30	174	5GB174C	367.85	85.0	30	228	5GB228C	497.30	111.0
36	66	5GE066C	154.50	35.0	36	120	5GE120C	263.75	61.0	36	174	5GE174C	375.15	87.0	36	228	5GE228C	500.35	114.0
42	66	5GH066C	160.20	36.0	42	120	5GH120C	272.85	64.0	42	174	5GH174C	388.55	92.0	42	228	5GH228C	524.20	119.0
48	66	5GL066C	165.30	37.0	48	120	5GL120C	282.45	65.0	48	174	5GL174C	402.10	94.0	48	228	5GL228C	541.65	123.0
54	66	5GP066C	171.25	39.0	54	120	5GP120C	291.60	69.0	54	174	5GP174C	415.45	99.0	54	228	5GP228C	565.10	128.0
60	66	5GS066C	187.95	40.0	60	120	5GS120C	297.55	71.0	60	174	5GS174C	421.95	101.0	60	228	5GS228C	565.10	128.0
30	72	5GB072C	163.90	36.0	30	126	5GB126C	279.60	62.0	30	180	5GB180C	377.75	87.0	30	234	5GB234C	507.35	113.0
36	72	5GE072C	167.30	37.0	36	126	5GE126C	285.75	63.0	36	180	5GE180C	385.85	89.0	36	234	5GE234C	516.75	116.0
42	72	5GH072C	173.05	38.0	42	126	5GH126C	295.30	66.0	42	180	5GH180C	398.45	95.0	42	234	5GH234C	534.95	121.0
48	72	5GL072C	176.95	39.0	48	126	5GL126C	305.50	68.0	48	180	5GL180C	411.20	97.0	48	234	5GL234C	551.25	125.0
54	72	5GP072C	182.80	42.0	54	126	5GP126C	314.85	72.0	54	180	5GP180C	425.25	101.0	54	234	5GP234C	568.80	130.0
60	72	5GS072C	187.05	43.0	60	126	5GS126C	320.75	73.0	60	180	5GS180C	432.20	103.0	60	234	5GS234C	568.80	130.0
30	78	5GB078C	176.95	38.0	30	132	5GB132C	297.00	64.0	30	186	5GB186C	387.00	89.0	30	240	5GB240C	517.20	116.0
36	78	5GE078C	181.00	39.0	36	132	5GE132C	302.55	65.0	36	186	5GE186C	394.15	91.0	36	240	5GE240C	527.05	118.0
42	78	5GH078C	187.05	40.0	42	132	5GH132C	311.85	69.0	42	186	5GH186C	408.00	97.0	42	240	5GH240C	544.85	123.0
48	78	5GL078C	190.95	42.0	48	132	5GL132C	319.95	71.0	48	186	5GL186C	420.75	99.0	48	240	5GL240C	561.80	127.0
54	78	5GP078C	197.10	44.0	54	132	5GP132C	328.15	74.0	54	186	5GP186C	434.55	103.0	54	240	5GP240C	579.35	132.0
60	78	5GS078C	202.75	45.0	60	132	5GS132C	337.75	75.0	60	186	5GS186C	441.45	105.0	60	240	5GS240C	579.35	132.0
30	84	5GB084C	200.40	45.0	30	138	5GB138C	306.25	66.0	30	192	5GB192C	403.15	94.0	30	246	5GB246C	527.05	118.0
36	84	5GE084C	209.90	47.0	36	138	5GE138C	311.85	67.0	36	192	5GE192C	410.70	96.0	36	246	5GE246C	534.95	121.0
42	84	5GH084C	219.15	50.0	42	138	5GH138C	321.65	71.0	42	192	5GH192C	424.10	100.0	42	246	5GH246C	551.25	125.0
48	84	5GL084C	229.10	52.0	48	138	5GL138C	329.75	74.0	48	192	5GL192C	437.30	102.0	48	246	5GL246C	568.80	130.0
54	84	5GP084C	234.60	54.0	54	138	5GP138C	335.80	76.0	54	192	5GP192C	447.05	105.0	54	246	5GP246C	585.10	135.0
60	84	5GS084C	244.35	58.0	60	138	5GS138C	343.20	77.0	60	192	5GS192C	458.05	110.0	60	246	5GS246C	585.10	135.0
30	90	5GB090C	209.45	48.0	30	144	5GB144C	323.05	73.0	30	198	5GB198C	426.70	97.0	30	252	5GB252C	544.85	123.0
36	90	5GE090C	218.55	49.0	36	144	5GE144C	335.80	74.0	36	198	5GE198C	434.25	98.0	36	252	5GE252C	551.25	125.0
42	90	5GH090C	228.35	52.0	42	144	5GH144C	349.90	79.0	42	198	5GH198C	447.60	102.0	42	252	5GH252C	568.80	130.0
48	90	5GL090C	237.00	55.0	48	144	5GL144C	363.35	83.0	48	198	5GL198C	463.25	105.0	48	252	5GL252C	585.10	135.0
54	90	5GP090C	243.55	57.0	54	144	5GP144C	371.45	85.0	54	198	5GP198C	471.45	108.0	54	252	5GP252C	601.35	140.0
60	90	5GS090C	252.75	60.0	60	144	5GS144C	385.00	89.0	60	198	5GS198C	483.30	110.0	60	252	5GS252C	601.35	140.0
30	96	5GB096C	218.15	50.0	30	150	5GB150C	326.90	75.0	30	204	5GB204C	443.25	100.0	30	258	5GB258C	617.60	145.0
36	96	5GE096C	227.20	51.0	36	150	5GE150C	340.15	77.0	36	204	5GE204C	451.90	102.0	36	258	5GE258C	624.05	147.0
42	96	5GH096C	236.70	54.0	42	150	5GH150C	353.35	81.0	42	204	5GH204C	464.95	105.0	42	258	5GH258C	640.30	152.0
48	96	5GL096C	246.55	57.0	48	150	5GL150C	367.20	85.0	48	204	5GL204C	474.60	108.0	48	258	5GL258C	656.55	157.0
54	96	5GP096C	252.45	59.0	54	150	5GP150C	374.75	87.0	54	204	5GP204C	484.50	111.0	54	258	5GP258C	672.80	162.0
60	96	5GS096C	262.05	62.0	60	150	5GS150C	387.80	91.0	60	204	5GS204C	492.40	113.0	60	258	5GS258C	672.80	162.0

See Pallet Rack Upright Frame Capacity Chart for frame capacity at various beam spacing.



Standard Pallet Rack Upright Frames



Frame Type P 3" wide x 3" deep Post - 14 Gauge

W	H	PART #	PRICE	WT.
30	48	5RB048C	140.65	33.0
36	48	5RE048C	146.45	34.0
42	48	5RH048C	152.30	36.0
48	48	5RL048C	157.80	38.0
54	48	5RP048C	161.65	39.0
60	48	5RS048C	167.60	42.0
30	54	5RB054C	152.30	36.0
36	54	5RE054C	158.70	37.0
42	54	5RH054C	163.65	39.0
48	54	5RL054C	169.70	42.0
54	54	5RP054C	174.00	43.0
60	54	5RS054C	179.20	44.0
30	60	5RB060C	167.75	40.0
36	60	5RE060C	171.70	42.0
42	60	5RH060C	176.65	44.0
48	60	5RL060C	182.90	45.0
54	60	5RP060C	189.45	46.0
60	60	5RS060C	192.75	47.0
30	66	5RB066C	179.55	44.0
36	66	5RE066C	183.40	45.0
42	66	5RH066C	189.75	46.0
48	66	5RL066C	195.05	47.0
54	66	5RP066C	200.95	49.0
60	66	5RS066C	204.90	50.0
30	72	5RB072C	189.45	47.0
36	72	5RE072C	199.40	48.0
42	72	5RH072C	204.80	49.0
48	72	5RL072C	208.90	50.0
54	72	5RP072C	214.50	52.0
60	72	5RS072C	220.45	53.0
30	78	5RB078C	208.05	49.0
36	78	5RE078C	211.50	50.0
42	78	5RH078C	216.95	52.0
48	78	5RL078C	221.25	53.0
54	78	5RP078C	227.20	55.0
60	78	5RS078C	238.40	57.0
30	84	5RB084C	233.35	57.0
36	84	5RE084C	242.65	58.0
42	84	5RH084C	251.70	62.0
48	84	5RL084C	261.10	65.0
54	84	5RP084C	266.35	66.0
60	84	5RS084C	276.20	70.0
30	90	5RB090C	244.35	60.0
36	90	5RE090C	253.35	61.0
42	90	5RH090C	262.50	64.0
48	90	5RL090C	272.00	68.0
54	90	5RP090C	278.95	70.0
60	90	5RS090C	287.65	73.0
30	96	5RB096C	256.25	63.0
36	96	5RE096C	264.95	64.0
42	96	5RH096C	279.60	68.0
48	96	5RL096C	287.65	71.0
54	96	5RP096C	289.90	73.0
60	96	5RS096C	299.25	76.0

W	H	PART #	PRICE	WT.
30	102	5RB102C	269.70	66.0
36	102	5RE102C	278.95	68.0
42	102	5RH102C	288.40	71.0
48	102	5RL102C	297.55	74.0
54	102	5RP102C	303.35	76.0
60	102	5RS102C	313.50	79.0
30	108	5RB108C	289.40	70.0
36	108	5RE108C	294.60	72.0
42	108	5RH108C	304.75	75.0
48	108	5RL108C	313.50	76.0
54	108	5RP108C	322.90	79.0
60	108	5RS108C	328.65	81.0
30	114	5RB114C	300.85	74.0
36	114	5RE114C	306.45	75.0
42	114	5RH114C	315.75	79.0
48	114	5RL114C	325.15	80.0
54	114	5RP114C	334.35	83.0
60	114	5RS114C	340.15	84.0
30	120	5RB120C	314.55	77.0
36	120	5RE120C	319.35	78.0
42	120	5RH120C	329.75	81.0
48	120	5RL120C	338.70	83.0
54	120	5RP120C	348.80	86.0
60	120	5RS120C	354.00	87.0
30	126	5RB126C	334.65	80.0
36	126	5RE126C	341.15	81.0
42	126	5RH126C	350.10	84.0
48	126	5RL126C	359.65	86.0
54	126	5RP126C	370.80	89.0
60	126	5RS126C	375.80	90.0
30	132	5RB132C	354.25	83.0
36	132	5RE132C	361.10	84.0
42	132	5RH132C	369.70	87.0
48	132	5RL132C	377.60	89.0
54	132	5RP132C	385.85	92.0
60	132	5RS132C	391.15	94.0
30	138	5RB138C	366.40	86.0
36	138	5RE138C	372.10	87.0
42	138	5RH138C	381.35	90.0
48	138	5RL138C	385.85	91.0
54	138	5RP138C	397.30	96.0
60	138	5RS138C	403.15	97.0
30	144	5RB144C	385.85	92.0
36	144	5RE144C	399.35	95.0
42	144	5RH144C	412.60	99.0
48	144	5RL144C	425.90	104.0
54	144	5RP144C	434.25	106.0
60	144	5RS144C	441.45	110.0
30	150	5RB150C	395.05	96.0
36	150	5RE150C	408.00	98.0
42	150	5RH150C	421.30	102.0
48	150	5RL150C	426.20	107.0
54	150	5RP150C	443.05	109.0
60	150	5RS150C	456.00	113.0

W	H	PART #	PRICE	WT.
30	156	5RB156C	418.40	101.0
36	156	5RE156C	426.20	103.0
42	156	5RH156C	439.35	108.0
48	156	5RL156C	453.10	110.0
54	156	5RP156C	466.35	115.0
60	156	5RS156C	482.75	117.0
30	162	5RB162C	429.70	104.0
36	162	5RE162C	437.40	106.0
42	162	5RH162C	451.90	111.0
48	162	5RL162C	464.50	113.0
54	162	5RP162C	478.65	118.0
60	162	5RS162C	486.55	120.0
30	168	5RB168C	441.90	107.0
36	168	5RE168C	449.80	109.0
42	168	5RH168C	463.25	114.0
48	168	5RL168C	476.20	116.0
54	168	5RP168C	490.05	121.0
60	168	5RS168C	498.15	123.0
30	174	5RB174C	446.30	110.0
36	174	5RE174C	454.15	112.0
42	174	5RH174C	466.90	116.0
48	174	5RL174C	480.15	119.0
54	174	5RP174C	494.20	124.0
60	174	5RS174C	501.45	126.0
30	180	5RB180C	459.15	113.0
36	180	5RE180C	466.90	116.0
42	180	5RH180C	480.00	120.0
48	180	5RL180C	493.05	122.0
54	180	5RP180C	505.80	127.0
60	180	5RS180C	514.20	128.0
30	186	5RB186C	471.10	117.0
36	186	5RE186C	478.25	119.0
42	186	5RH186C	491.30	123.0
48	186	5RL186C	504.60	125.0
54	186	5RP186C	518.55	129.0
60	186	5RS186C	526.30	131.0
30	192	5RB192C	490.65	121.0
36	192	5RE192C	498.15	123.0
42	192	5RH192C	510.95	128.0
48	192	5RL192C	524.20	130.0
54	192	5RP192C	533.35	132.0
60	192	5RS192C	545.00	136.0
30	198	5RB198C	536.05	125.0
36	198	5RE198C	544.40	127.0
42	198	5RH198C	557.90	130.0
48	198	5RL198C	572.55	134.0
54	198	5RP198C	583.05	137.0
60	198	5RS198C	595.15	140.0
30	204	5RB204C	557.05	130.0
36	204	5RE204C	565.10	132.0
42	204	5RH204C	579.35	135.0
48	204	5RL204C	589.60	137.0
54	204	5RP204C	599.50	140.0
60	204	5RS204C	608.10	142.0

W	H	PART #	PRICE	WT.
30	210	5RB210C	576.35	133.0
36	210	5RE210C	584.70	135.0
42	210	5RH210C	599.00	138.0
48	210	5RL210C	609.95	140.0
54	210	5RP210C	619.25	143.0
60	210	5RS210C	627.30	146.0
30	216	5RB216C	615.85	138.0
36	216	5RE216C	634.05	140.0
42	216	5RH216C	653.20	146.0
48	216	5RL216C	670.95	150.0
54	216	5RP216C	681.15	157.0
60	216	5RS216C	630.65	159.0
30	222	5RB222C	611.35	146.0
36	222	5RE222C	621.30	143.0
42	222	5RH222C	639.10	146.0
48	222	5RL222C	656.50	153.0
54	222	5RP222C	675.95	159.0
30	228	5RB228C	624.95	145.0
36	228	5RE228C	634.85	147.0
42	228	5RH228C	653.20	151.0
48	228	5RL228C	670.95	156.0
54	228	5RP228C	689.10	160.0
30	234	5RB234C	638.30	147.0
36	234	5RE234C	648.15	150.0
42	234	5RH234C	666.70	154.0
48	234	5RL234C	684.45	158.0
54	234	5RP234C	686.85	163.0
30	240	5RB240C	652.20	150.0
36	240	5RE240C	661.35	153.0
42	240	5RH240C	679.45	157.0
48	240	5RL240C	692.75	161.0
54	240	5RP240C	716.25	166.0

See Pallet Rack Upright Frame Capacity Chart for frame capacity at various beam spacing.

The price books are only for reference, if there are any discrepancies between the price book and EQ, EQ will override the price book.

Order by Catalog Number Only



Standard Pallet Rack Upright Frames



Frame Type R 3" wide x 3" deep Post - 13 Gauge

W	H	PART #	PRICE	WT.
30	48	5RB048C	130.20	33.0
36	48	5RE048C	135.60	34.0
42	48	5RH048C	141.00	36.0
48	48	5RL048C	146.10	38.0
54	48	5RP048C	149.65	39.0
60	48	5RS048C	155.15	42.0
30	54	5RB054C	141.00	36.0
36	54	5RE054C	146.90	37.0
42	54	5RH054C	151.50	39.0
48	54	5RL054C	157.10	42.0
54	54	5RP054C	161.10	43.0
60	54	5RS054C	165.90	44.0
30	60	5RB060C	155.30	40.0
36	60	5RE060C	158.95	42.0
42	60	5RH060C	163.55	44.0
48	60	5RL060C	169.35	45.0
54	60	5RP060C	175.40	46.0
60	60	5RS060C	178.45	47.0
30	66	5RB066C	166.25	44.0
36	66	5RE066C	169.80	45.0
42	66	5RH066C	175.65	46.0
48	66	5RL066C	180.60	47.0
54	66	5RP066C	186.05	49.0
60	66	5RS066C	189.70	50.0
30	72	5RB072C	175.40	47.0
36	72	5RE072C	184.60	48.0
42	72	5RH072C	189.60	49.0
48	72	5RL072C	193.40	50.0
54	72	5RP072C	198.60	52.0
60	72	5RS072C	204.10	53.0
30	78	5RB078C	192.60	49.0
36	78	5RE078C	195.80	50.0
42	78	5RH078C	200.85	52.0
48	78	5RL078C	204.85	53.0
54	78	5RP078C	210.35	55.0
60	78	5RS078C	220.70	57.0
30	84	5RB084C	216.05	57.0
36	84	5RE084C	224.65	58.0
42	84	5RH084C	233.05	62.0
48	84	5RL084C	241.75	65.0
54	84	5RP084C	246.60	66.0
60	84	5RS084C	255.70	70.0
30	90	5RB090C	226.25	60.0
36	90	5RE090C	234.55	61.0
42	90	5RH090C	243.05	64.0
48	90	5RL090C	251.85	68.0
54	90	5RP090C	258.25	70.0
60	90	5RS090C	266.30	73.0
30	96	5RB096C	237.25	63.0
36	96	5RE096C	245.30	64.0
42	96	5RH096C	258.85	68.0
48	96	5RL096C	266.30	71.0
54	96	5RP096C	268.40	73.0
60	96	5RS096C	277.05	76.0

W	H	PART #	PRICE	WT.
30	102	5RB102C	269.70	66.0
36	102	5RE102C	278.95	68.0
42	102	5RH102C	288.40	71.0
48	102	5RL102C	297.55	74.0
54	102	5RP102C	303.35	76.0
60	102	5RS102C	313.50	79.0
30	108	5RB108C	289.40	70.0
36	108	5RE108C	294.60	72.0
42	108	5RH108C	304.75	75.0
48	108	5RL108C	313.50	76.0
54	108	5RP108C	322.90	79.0
60	108	5RS108C	328.65	81.0
30	114	5RB114C	300.85	74.0
36	114	5RE114C	306.45	75.0
42	114	5RH114C	315.75	79.0
48	114	5RL114C	325.15	80.0
54	114	5RP114C	334.35	83.0
60	114	5RS114C	340.15	84.0
30	120	5RB120C	314.55	77.0
36	120	5RE120C	319.35	78.0
42	120	5RH120C	329.75	81.0
48	120	5RL120C	338.70	83.0
54	120	5RP120C	348.80	86.0
60	120	5RS120C	354.00	87.0
30	126	5RB126C	334.65	80.0
36	126	5RE126C	341.15	81.0
42	126	5RH126C	350.10	84.0
48	126	5RL126C	359.65	86.0
54	126	5RP126C	370.80	89.0
60	126	5RS126C	375.80	90.0
30	132	5RB132C	354.25	83.0
36	132	5RE132C	361.10	84.0
42	132	5RH132C	369.70	87.0
48	132	5RL132C	377.60	89.0
54	132	5RP132C	385.85	92.0
60	132	5RS132C	391.15	94.0
30	138	5RB138C	366.40	86.0
36	138	5RE138C	372.10	87.0
42	138	5RH138C	381.35	90.0
48	138	5RL138C	385.85	91.0
54	138	5RP138C	397.30	96.0
60	138	5RS138C	403.15	97.0
30	144	5RB144C	385.85	92.0
36	144	5RE144C	399.35	95.0
42	144	5RH144C	412.60	99.0
48	144	5RL144C	425.90	104.0
54	144	5RP144C	434.25	106.0
60	144	5RS144C	441.45	110.0
30	150	5RB150C	395.05	96.0
36	150	5RE150C	408.00	98.0
42	150	5RH150C	421.30	102.0
48	150	5RL150C	426.20	107.0
54	150	5RP150C	443.05	109.0
60	150	5RS150C	456.00	113.0

W	H	PART #	PRICE	WT.
30	156	5RB156C	418.40	101.0
36	156	5RE156C	426.20	103.0
42	156	5RH156C	439.35	108.0
48	156	5RL156C	453.10	110.0
54	156	5RP156C	466.35	115.0
60	156	5RS156C	482.75	117.0
30	162	5RB162C	429.70	104.0
36	162	5RE162C	437.40	106.0
42	162	5RH162C	451.90	111.0
48	162	5RL162C	464.50	113.0
54	162	5RP162C	478.65	118.0
60	162	5RS162C	486.55	120.0
30	168	5RB168C	441.90	107.0
36	168	5RE168C	449.80	109.0
42	168	5RH168C	463.25	114.0
48	168	5RL168C	476.20	116.0
54	168	5RP168C	490.05	121.0
60	168	5RS168C	498.15	123.0
30	174	5RB174C	446.30	110.0
36	174	5RE174C	454.15	112.0
42	174	5RH174C	466.90	116.0
48	174	5RL174C	480.15	119.0
54	174	5RP174C	494.20	124.0
60	174	5RS174C	501.45	126.0
30	180	5RB180C	459.15	113.0
36	180	5RE180C	466.90	116.0
42	180	5RH180C	480.00	120.0
48	180	5RL180C	493.05	122.0
54	180	5RP180C	505.80	127.0
60	180	5RS180C	514.20	128.0
30	186	5RB186C	471.10	117.0
36	186	5RE186C	478.25	119.0
42	186	5RH186C	491.30	123.0
48	186	5RL186C	504.60	125.0
54	186	5RP186C	518.55	129.0
60	186	5RS186C	526.30	131.0
30	192	5RB192C	490.65	121.0
36	192	5RE192C	498.15	123.0
42	192	5RH192C	510.95	128.0
48	192	5RL192C	524.20	130.0
54	192	5RP192C	533.35	132.0
60	192	5RS192C	545.00	136.0
30	198	5RB198C	536.05	125.0
36	198	5RE198C	544.40	127.0
42	198	5RH198C	557.90	130.0
48	198	5RL198C	572.55	134.0
54	198	5RP198C	583.05	137.0
60	198	5RS198C	595.15	140.0
30	204	5RB204C	557.05	130.0
36	204	5RE204C	565.10	132.0
42	204	5RH204C	579.35	135.0
48	204	5RL204C	589.60	137.0
54	204	5RP204C	599.50	140.0
60	204	5RS204C	608.10	142.0

W	H	PART #	PRICE	WT.
30	210	5RB210C	576.35	133.0
36	210	5RE210C	584.70	135.0
42	210	5RH210C	599.00	138.0
48	210	5RL210C	609.95	140.0
54	210	5RP210C	619.25	143.0
60	210	5RS210C	627.30	146.0
30	216	5RB216C	615.85	138.0
36	216	5RE216C	634.05	140.0
42	216	5RH216C	653.20	146.0
48	216	5RL216C	670.95	150.0
54	216	5RP216C	681.15	157.0
60	216	5RS216C	630.65	159.0
30	222	5RB222C	611.35	146.0
36	222	5RE222C	621.30	143.0
42	222	5RH222C	639.10	146.0
48	222	5RL222C	656.50	153.0
54	222	5RP222C	675.95	159.0
30	228	5RB228C	624.95	145.0
36	228	5RE228C	634.85	147.0
42	228	5RH228C	653.20	151.0
48	228	5RL228C	670.95	156.0
54	228	5RP228C	689.10	160.0
30	234	5RB234C	638.30	147.0
36	234	5RE234C	648.15	150.0
42	234	5RH234C	666.70	154.0
48	234	5RL234C	684.45	158.0
54	234	5RP234C	686.85	163.0
30	240	5RB240C	652.20	150.0
36	240	5RE240C	661.35	153.0
42	240	5RH240C	679.45	157.0
48	240	5RL240C	692.75	161.0
54	240	5RP240C	716.25	166.0

See Pallet Rack Upright Frame Capacity Chart for frame capacity at various beam spacing.

The price books are only for reference, if there are any discrepancies between the price book and EQ, EQ will override the price book.
Order by Catalog Number Only



Standard Pallet Rack Upright Frames



Frame Type T 3" wide x 3" deep Post - 12 Gauge

W	H	PART #	PRICE	WT.	W	H	PART #	PRICE	WT.	W	H	PART #	PRICE	WT.	W	H	PART #	PRICE	WT.
30	48	5TB048C	155.00	37.0	30	102	5TB102C	297.45	73.0	30	156	5TB156C	456.70	112.0	30	210	5TB210C	624.95	147.0
36	48	5TE048C	160.20	39.0	36	102	5TE102C	306.45	75.0	36	156	5TE156C	464.50	114.0	36	210	5TE210C	632.45	150.0
42	48	5TH048C	165.55	41.0	42	102	5TH102C	314.85	77.0	42	156	5TH156C	476.90	117.0	42	210	5TH210C	645.90	153.0
48	48	5TL048C	171.35	43.0	48	102	5TL102C	324.40	79.0	48	156	5TL156C	490.05	120.0	48	210	5TL210C	656.10	156.0
54	48	5TP048C	175.00	45.0	54	102	5TP102C	329.75	81.0	54	156	5TP156C	505.80	123.0	54	210	5TP210C	664.65	159.0
60	48	5TS048C	180.65	47.0	60	102	5TS102C	335.10	83.0	60	156	5TS156C	510.70	126.0	60	210	5TS210C	672.50	162.0
30	54	5TB054C	167.75	40.0	30	108	5TB108C	318.40	78.0	30	162	5TB162C	470.00	116.0	30	216	5TB216C	657.30	152.0
36	54	5TE054C	173.60	42.0	36	108	5TE108C	322.90	80.0	36	162	5TE162C	477.40	119.0	36	216	5TE216C	667.15	155.0
42	54	5TH054C	178.70	44.0	42	108	5TH108C	331.75	82.0	42	162	5TH162C	491.10	122.0	42	216	5TH216C	684.10	158.0
48	54	5TL054C	189.75	46.0	48	108	5TL108C	341.40	84.0	48	162	5TL162C	504.00	125.0	48	216	5TL216C	701.05	161.0
54	54	5TP054C	192.15	48.0	54	108	5TP108C	349.90	86.0	54	162	5TP162C	517.20	128.0	54	216	5TP216C	717.90	164.0
60	54	5TS054C	196.15	50.0	60	108	5TS108C	356.40	88.0	60	162	5TS162C	524.10	131.0	60	216	5TS216C	727.85	167.0
30	60	5TB060C	184.10	44.0	30	114	5TB114C	330.30	82.0	30	168	5TB168C	483.10	119.0	30	222	5TB222C	663.15	156.0
36	60	5TE060C	189.45	46.0	36	114	5TE114C	340.40	84.0	36	168	5TE168C	491.10	122.0	36	222	5TE222C	672.80	159.0
42	60	5TH060C	193.70	48.0	42	114	5TH114C	344.40	86.0	42	168	5TH168C	504.40	125.0	42	222	5TH222C	690.75	162.0
48	60	5TL060C	199.40	50.0	48	114	5TL114C	353.35	88.0	48	168	5TL168C	517.20	128.0	48	222	5TL222C	707.15	166.0
54	60	5TP060C	203.55	52.0	54	114	5TP114C	362.45	90.0	54	168	5TP168C	530.05	131.0	54	222	5TP222C	724.25	170.0
60	60	5TS060C	208.05	54.0	60	114	5TS114C	367.85	92.0	60	168	5TS168C	536.55	134.0	30	228	5TB228C	679.45	159.0
30	66	5TB066C	196.00	48.0	30	120	5TB120C	342.60	85.0	30	174	5TB174C	491.30	123.0	36	228	5TE228C	688.25	162.0
36	66	5TE066C	204.95	50.0	36	120	5TE120C	348.80	87.0	36	174	5TE174C	510.95	125.0	42	228	5TH228C	705.05	166.0
42	66	5TH066C	207.00	52.0	42	120	5TH120C	357.75	89.0	42	174	5TH174C	510.95	128.0	48	228	5TL228C	721.90	170.0
48	66	5TL066C	212.75	54.0	48	120	5TL120C	366.40	91.0	48	174	5TL174C	525.10	132.0	54	228	5TP228C	740.00	174.0
54	66	5TP066C	217.70	56.0	54	120	5TP120C	375.15	93.0	54	174	5TP174C	537.40	135.0	30	234	5TB234C	697.90	162.0
60	66	5TS066C	222.15	58.0	60	120	5TS120C	380.70	95.0	60	174	5TS174C	544.40	138.0	36	234	5TE234C	702.80	166.0
30	72	5TB072C	213.70	52.0	30	126	5TB126C	371.05	89.0	30	180	5TB180C	506.45	126.0	42	234	5TH234C	720.65	170.0
36	72	5TE072C	218.15	54.0	36	126	5TE126C	376.50	91.0	36	180	5TE180C	513.10	129.0	48	234	5TL234C	736.95	174.0
42	72	5TH072C	223.50	56.0	42	126	5TH126C	385.85	93.0	42	180	5TH180C	525.45	132.0	54	234	5TP234C	753.95	178.0
48	72	5TL072C	227.95	58.0	48	126	5TL126C	394.15	95.0	48	180	5TL180C	538.45	135.0	30	240	5TB240C	708.65	166.0
54	72	5TP072C	233.85	60.0	54	126	5TP126C	404.55	97.0	54	180	5TP180C	551.80	138.0	36	240	5TE240C	718.20	170.0
60	72	5TS072C	239.40	62.0	60	126	5TS126C	410.20	99.0	60	180	5TS180C	558.40	140.0	42	240	5TH240C	735.25	174.0
30	78	5TB078C	232.75	56.0	30	132	5TB132C	391.15	94.0	30	186	5TB186C	518.55	130.0	48	240	5TL240C	752.75	178.0
36	78	5TE078C	237.00	58.0	36	132	5TE132C	395.05	96.0	36	186	5TE186C	526.30	133.0	54	240	5TP240C	769.35	182.0
42	78	5TH078C	242.65	60.0	42	132	5TH132C	405.60	98.0	42	186	5TH186C	538.80	135.0					
48	78	5TL078C	246.55	62.0	48	132	5TL132C	413.35	100.0	48	186	5TL186C	551.80	138.0					
54	78	5TP078C	253.35	64.0	54	132	5TP132C	420.75	102.0	54	186	5TP186C	564.55	141.0					
60	78	5TS078C	258.25	66.0	60	132	5TS132C	426.20	104.0	60	186	5TS186C	572.15	144.0					
30	84	5TB084C	260.15	63.0	30	138	5TB138C	404.55	94.0	30	192	5TB192C	539.10	135.0					
36	84	5TE084C	269.10	65.0	36	138	5TE138C	410.20	96.0	36	192	5TE192C	547.25	137.0					
42	84	5TH084C	277.75	67.0	42	138	5TH138C	419.50	98.0	42	192	5TH192C	559.55	140.0					
48	84	5TL084C	287.45	69.0	48	138	5TL138C	426.70	100.0	48	192	5TL192C	571.70	143.0					
54	84	5TP084C	292.80	71.0	54	138	5TP138C	434.25	106.0	54	192	5TP192C	581.35	146.0					
60	84	5TS084C	302.05	73.0	60	138	5TS138C	440.25	108.0	60	192	5TS192C	592.30	149.0					
30	90	5TB090C	272.85	66.0	30	144	5TB144C	425.90	103.0	30	198	5TB198C	576.10	138.0					
36	90	5TE090C	281.65	68.0	36	144	5TE144C	438.45	106.0	36	198	5TE198C	583.70	140.0					
42	90	5TH090C	291.20	70.0	42	144	5TH144C	451.50	109.0	42	198	5TH198C	596.40	143.0					
48	90	5TL090C	299.70	72.0	48	144	5TL144C	464.05	112.0	48	198	5TL198C	609.95	146.0					
54	90	5TP090C	308.75	74.0	54	144	5TP144C	467.10	115.0	54	198	5TP198C	619.25	149.0					
60	90	5TS090C	314.10	76.0	60	144	5TS144C	485.55	118.0	60	198	5TS198C	630.60	152.0					
30	96	5TB096C	285.15	70.0	30	150	5TB150C	433.35	106.0	30	204	5TB204C	596.55	143.0					
36	96	5TE096C	294.60	72.0	36	150	5TE150C	446.05	109.0	36	204	5TE204C	604.65	145.0					
42	96	5TH096C	304.95	74.0	42	150	5TH150C	458.05	112.0	42	204	5TH204C	618.05	149.0					
48	96	5TL096C	313.00	76.0	48	150	5TL150C	471.45	115.0	48	204	5TL204C	626.60	153.0					
54	96	5TP096C	320.75	78.0	54	150	5TP150C	479.35	118.0	54	204	5TP204C	637.50	156.0					
60	96	5TS096C	327.25	80.0	60	150	5TS150C	491.85	121.0	60	204	5TS204C	645.15	159.0					

The price books are only for reference, if there are any discrepancies between the price book and EQ, EQ will override the price book.

Order by Catalog Number Only



Standard Pallet Rack Beams



W	D	H	*	Cat. No.	Price	Per	Wt.	Pkg.
---	---	---	---	----------	-------	-----	-----	------

W	D	H	*	Cat. No.	Price	Per	Wt.	Pkg.
---	---	---	---	----------	-------	-----	-----	------

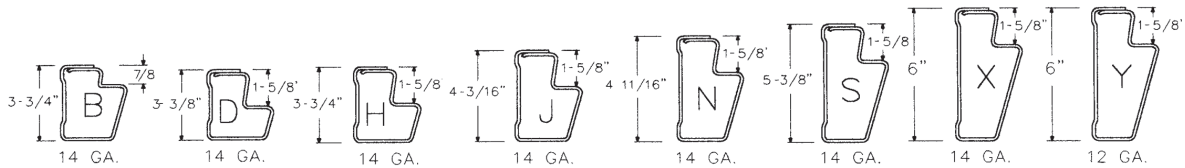

W	H	Capacity Lbs. **	Cat. No.	Price per Pair	Wt. Pair
---	---	---------------------	----------	-------------------	-------------

W	H	Capacity Lbs. **	Cat. No.	Price per Pair	Wt. Pair
---	---	---------------------	----------	-------------------	-------------

Typical Beam
Depth Dimensions

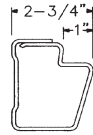

Pallet Rack Beams

48" Clear Span

7/8" Step

48	3-3/4	8920	5BB048	155.20	35.0
1-5/8" Step					
48	3-3/8	8380	5BD048	151.80	33.0
48	3-3/4	9430	5BH048	155.20	35.0
48	4-3/16	10670	5BJ048	160.30	36.0
48	4-11/16	12170	5BN048	168.40	38.0

54" Clear Span

7/8" Step

54	3-3/4	7920	5BB054	167.30	38.0
1-5/8" Step					
54	3-3/8	7445	5BD054	161.70	37.0
54	3-3/4	8370	5BH054	167.30	38.0
54	4-3/16	9480	5BJ054	173.05	40.0
54	4-11/16	10810	5BN054	181.45	42.0

60" Clear Span

7/8" Step

60	3-3/4	7120	5BB060	179.30	42.0
1-5/8" Step					
60	3-3/8	6695	5BD060	173.35	40.0
60	3-3/4	7530	5BH060	179.30	42.0
60	4-3/16	8520	5BJ060	185.90	44.0
60	4-11/16	9730	5BN060	194.20	46.0

66" Clear Span

7/8" Step

66	3-3/4	6470	5BB066	190.75	45.0
1-5/8" Step					
66	3-3/8	6080	5BD066	185.95	43.0
66	3-3/4	6840	5BH066	190.75	45.0
66	4-3/16	7740	5BJ066	197.70	47.0
66	4-11/16	8830	5BN066	207.20	50.0

72" Clear Span

7/8" Step

72	3-3/4	5920	5BB072	202.50	49.0
1-5/8" Step					
72	3-3/8	5570	5BD072	198.35	47.0
72	3-3/4	6260	5BH072	202.50	49.0
72	4-3/16	7090	5BJ072	210.15	51.0
72	4-11/16	8090	5BN072	220.45	54.0
72	5-3/8	9560	5BS072	233.20	57.0

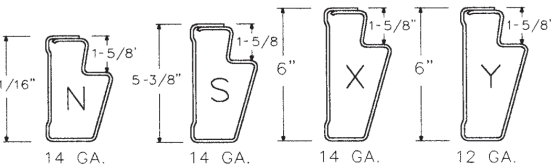

78" Clear Span

7/8" Step

78	3-3/4	5460	5BB078	214.60	52.0
----	-------	------	--------	--------	------

1-5/8" Step

78	3-3/8	5135	5BD078	210.95	50.0
78	3-3/4	5770	5BH078	214.60	52.0
78	4-3/16	6540	5BJ078	223.05	55.0
78	4-11/16	7460	5BN078	233.90	58.0
78	6	10220	5BX078	269.10	65.0

84" Clear Span

7/8" Step

84	3-3/4	5070	5BB084	226.20	56.0
----	-------	------	--------	--------	------

1-5/8" Step

84	3-3/8	4760	5BD084	222.90	53.0
84	3-3/4	5360	5BH084	226.20	56.0
84	4-3/16	6060	5BJ084	235.45	58.0
84	4-11/16	6920	5BN084	247.05	62.0
84	6	9480	5BX084	284.70	70.0
84	6	12650	5BY084	343.25	92.0

90" Clear Span

7/8" Step

90	3-3/4	4720	5BB090	237.95	59.0
----	-------	------	--------	--------	------

1-5/8" Step

90	3-3/8	4430	5BD090	233.90	57.0
90	3-3/4	4990	5BH090	237.95	59.0
90	4-3/16	5650	5BJ090	247.70	62.0
90	4-11/16	6450	5BN090	260.15	65.0
90	5-3/8	7630	5BS090	276.20	70.0
90	6	8840	5BX090	302.00	74.0
90	6	11800	5BY090	367.75	99.0

96" Clear Span

7/8" Step

96	3-3/4	4420	5BB096	249.50	63.0
----	-------	------	--------	--------	------

1-5/8" Step

96	3-3/8	3990	5BD096	245.45	60.0
96	3-3/4	4670	5BH096	249.50	63.0
96	4-3/16	5290	5BJ096	259.65	66.0
96	4-11/16	6040	5BN096	273.50	69.0
96	5-3/8	7190	5BS096	290.05	74.0
96	6	8280	5BX096	319.55	79.0
96	6	11050	5BY096	387.60	105.0

Traditional Color - 710 Sagebrush Yellow

Clear Span = Inside Frame to Inside Frame Dimension

** Capacity per Pair for Uniformly Distributed Load

Order by Catalog Number Only

The price books are only for reference, if there are any discrepancies between the price book and EQ, EQ will override the price book.

Order by Catalog Number Only



Standard Pallet Rack Beams



W	D	H	*	Cat. No.	Price	Per	Wt.	Pkg.
---	---	---	---	----------	-------	-----	-----	------

W	D	H	*	Cat. No.	Price	Per	Wt.	Pkg.
---	---	---	---	----------	-------	-----	-----	------

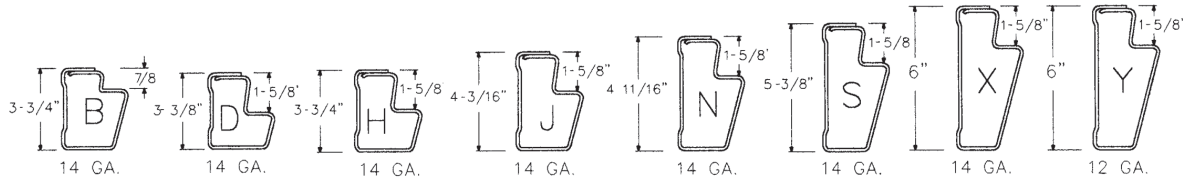

W	H	Capacity Lbs. **	Cat. No.	Price per Pair	Wt. Pair
102" Clear Span					
7/8" Step					
102	3-3/4	4160	5BB102	264.50	66.0
1-5/8" Step					
102	3-3/8	3530	5BD102	258.75	64.0
102	3-3/4	4390	5BH102	264.50	66.0
102	4-3/16	4980	5BJ102	275.25	70.0
102	4-11/16	5680	5BN102	289.85	73.0
102	5-3/8	6720	5BS102	307.45	79.0
102	6	7790	5BX102	335.60	83.0
102	6	10390	5BY102	413.60	111.0
108" Clear Span					
7/8" Step					
108	3-3/4	3920	5BB108	276.65	70.0
1-5/8" Step					
108	3-3/8	3150	5BD108	271.35	67.0
108	3-3/4	3990	5BH108	276.65	70.0
108	4-3/16	4690	5BJ108	288.35	73.0
108	4-11/16	5340	5BN108	303.35	77.0
108	5-3/8	6340	5BS108	322.15	83.0
108	6	7350	5BX108	352.95	88.0
108	6	9800	5BY108	434.35	117.0
114" Clear Span					
7/8" Step					
114	3-3/4	3540	5BB114	291.20	73.0
1-5/8" Step					
114	3-3/8	2830	5BD114	278.35	70.0
114	4-3/16	4440	5BJ114	303.55	77.0
114	6	6950	5BX114	369.20	92.0
114	6	9280	5BY114	455.20	123.0
120" Clear Span					
7/8" Step					
120	3-3/4	3190	5BB120	303.30	77.0
1-5/8" Step					
120	3-3/8	2550	5BD120	297.00	74.0
120	3-3/4	3230	5BH120	303.30	77.0
120	4-3/16	4130	5BJ120	316.30	81.0
120	4-11/16	4810	5BN120	333.20	85.0
120	5-3/8	5690	5BS120	354.00	91.0
120	6	6600	5BX120	387.00	97.0
120	6	8800	5BY120	475.75	129.0
126" Clear Span					
7/8" Step					
126	3-3/4	2900	5BB126	315.70	80.0
1-5/8" Step					
126	3-3/8	2310	5BD126	330.95	77.0
126	4-11/16	4570	5BN126	346.65	89.0
126	5-3/8	5410	5BS126	368.20	95.0
126	6	6270	5BX126	400.40	101.0
126	6	8370	5BY126	496.40	135.0

W	H	Capacity Lbs. **	Cat. No.	Price per Pair	Wt. Pair
132" Clear Span					
7/8" Step					
132	3-3/4	2840	5BB132	328.15	84.0
1-5/8" Step					
132	4-11/16	4410	5BN132	361.20	93.0
132	5-3/8	5160	5BS132	384.50	100.0
132	6	5980	5BX132	419.50	106.0
132	6	7980	5BY132	517.45	142.0
138" Clear Span					
7/8" Step					
138	3-3/4	2410	5BB138	340.75	87.0
1-5/8" Step					
138	4-11/16	4030	5BN138	374.75	97.0
138	6	5710	5BX138	434.25	110.0
138	6	7620	5BY138	538.05	148.0
144" Clear Span					
7/8" Step					
144	3-3/4	2220	5BB144	352.95	91.0
1-5/8" Step					
144	3-3/4	2240	5BH144	352.95	91.0
144	5-3/8	4740	5BS144	413.65	108.0
144	6	5500	5BX144	453.75	115.0
144	6	7340	5BY144	559.00	154.0

Traditional Color - 710 Sagebrush Yellow
 Clear Span = Inside Frame to Inside Frame Dimension
 ** Capacity per Pair for Uniformly Distributed Load
 Order by Catalog Number Only

W	D	H *	Cat. No.	Price	Per	Wt.	Pkg.
---	---	-----	----------	-------	-----	-----	------

W	D	H *	Cat. No.	Price	Per	Wt.	Pkg.
---	---	-----	----------	-------	-----	-----	------

Drum Wedges

Pairs

Attach to front beam only.

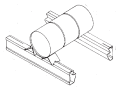

5AW000	14.10	Pr.	1.2
--------	-------	-----	-----

Pallet Stop - Pairs

For 1-5/8" Step Beams Only

Attaches to rear beam with Tek screw # 8822 (included).



4	3-1/4	4	5AT00H	37.05	Pr.	5.4
---	-------	---	--------	-------	-----	-----

Rigid Row Spacers, 12 Ga.

Hardware Included

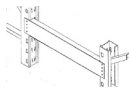

6	5AR506	12.45	Ea.	2.0
8	5AR508	14.10	Ea.	2.4
10	5AR510	15.70	Ea.	2.8
12	5AR512	16.95	Ea.	3.2
18	5AR518	22.15	Ea.	4.5
24	5AR524	26.75	Ea.	5.8
30	5AR530	32.10	Ea.	6.7
36	5AR536	36.75	Ea.	8.3
42	5AR542	41.75	Ea.	9.6
48	5AR548	45.75	Ea.	10.8
54	5AR554	50.30	Ea.	12.1
60	5AR560	54.65	Ea.	13.4

Rigid Wall Spacers, 12 Ga.

Frame Hardware Included

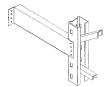

4	5AR404	28.55	Ea.	1.5
6	5AR406	29.35	Ea.	2.0
8	5AR408	30.85	Ea.	2.4
10	5AR410	31.60	Ea.	2.8
12	5AR412	31.00	Ea.	3.2
18	5AR418	35.70	Ea.	4.6

Reel Holder - Pairs

2-1/2" Diameter Max. Axle

Hardware Included. 1000 lb. capacity per pair maximum.

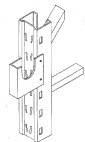

5AH000	26.75	Pr.	3.0
--------	-------	-----	-----

Cross Bar Load Ratings For Offset Pallet Conditions

- For pallet depths equal to or greater than frame depth.
- NOT for uniformly distributed load conditions.
- For series 5AX500, 5AX600 and 5AX700.
- For rigid pallets only.

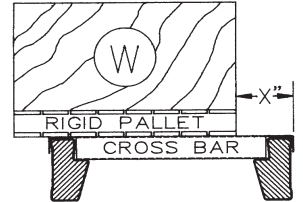

Frame Depth (inches)	Offset "X" (inches)	Max. Allowable Load "W" (lbs) on two Bars
36	4	6058
	5	3895
	6	2988
	7	2503
42	4	5960
	5	3786
	6	2868
	7	2370
48	4	5890
	5	3711
	6	2786
	7	2281
54	4	5838
	5	3655
	6	2727
	7	2217
60	4	5798
	5	3613
	6	2682
	7	2169

Frame Splice Channels - Pairs

Specify that top frame be manufactured without foot plates. Hardware included.



For Frame Type F, G & P

12	5AU008P	48.65	Pr.	4.5
----	---------	-------	-----	-----

For Frame Type R & T

12	5AU018P	50.40	Pr.	6.0
----	---------	-------	-----	-----

Frame Protector

Includes Frame Hardware

Floor Anchors Not Included.

Finished in 710 Yellow only. NOT for use with Pallet Rack PLUS upright frames.

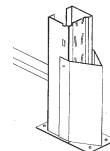

18	5AF018	74.80	Ea.	7.0
----	--------	-------	-----	-----

Self-Tapping screws are available for fastening accessories to beams. See Part No. 8822 in RivetRite Component Parts Section.



Pallet Rack Accessories

W	D	H	*	Cat. No.	Price	Per	Wt.	Pkg.
---	---	---	---	----------	-------	-----	-----	------

W	D	H	*	Cat. No.	Price	Per	Wt.	Pkg.
---	---	---	---	----------	-------	-----	-----	------

Frame Deflector

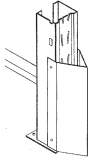

Finished 710 Yellow Only.

18 5AF021PC 40.30 Ea. 5.8

Drum Rack Unit



16-55 Gallon Drum Capacity

Consists of 4 pairs of "J" Beams, 2 "F" Uprights and 16 Coil Bed Assemblies.

120 36 120 55C016 3489.20 Unit 664.0

Concrete Floor Anchor

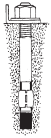

1/2"-13 x 3-3/4"

9580 6.45 Ea. 0.2

Shim, 7 Ga.

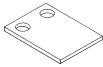

Rack Foot Plate, Unpainted

Has 2-9/16" Holes

3-1/4 4-1/4 55020C 3.65 Ea. 0.8

Shim for Pallet Rack PLUS Foot Plate, 7 Ga.

Specify color.

5 7 55021C 12.45 Ea. 1.0

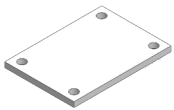

Touch Up Paint, Air Dry

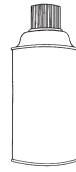

12 Oz. Spray Can, Air Dry

Tawny Tan	97012Z	77.70	Ea.	1.0
Gray Ash	97021Z	77.70	Ea.	1.0
Gray	97028Z	77.70	Ea.	1.0
Reflex Blue	97052Z	77.70	Ea.	1.0
Canvas	97054Z	77.70	Ea.	1.0
Shamrock	97055Z	77.70	Ea.	1.0
Sunburst	97056Z	77.70	Ea.	1.0
Nordic Purple	97058Z	77.70	Ea.	1.0
Champagne	97073Z	77.70	Ea.	1.0
Spray Green	97701Z	77.70	Ea.	1.0
Sagebrush Yellow	97710Z	77.70	Ea.	1.0
Lake Blue	97715Z	77.70	Ea.	1.0
Mandarin Orange	97720Z	77.70	Ea.	1.0
Patriot Red	97722Z	77.70	Ea.	1.0
Light Putty	97723Z	77.70	Ea.	1.0
Burgundy	97736Z	77.70	Ea.	1.0
Cardinal Red	97767Z	77.70	Ea.	1.0
Marine Blue	97806Z	77.70	Ea.	1.0
Hunter Green	97812Z	77.70	Ea.	1.0
Regal Blue	97822Z	77.70	Ea.	1.0
Slate Blue	97826Z	77.70	Ea.	1.0
January	97848Z	77.70	Ea.	1.0
Jet Black	97949Z	77.70	Ea.	1.0
Turquoise Teal	97952Z	77.70	Ea.	1.0

Gallon Cans

GALLON 488.30 Ea. 10.0

PRODUCTION ONLY

Custom Colors for Clipper, Erectomatic, Wide Span, & Pallet Rack **ONLY**.

Price below is based on 1500 pounds minimum. If under 1500 pounds, an SPI would be required.

- Anti-Graffiti and Anti-Microbial = 25% add (this is for any color, RAL, non-RAL, or even Penco colors)
 - RAL colors = 5% add
 - NON-RAL colors = 20% add

Spray Paint for RAL & NON-RAL - 44.00 NET - 12 can minimum - Part# SPRAYPAINT

RivetRite will remain SPI **ONLY**.